

Data Sheet



Article number: 03445090

Description: Fluro Heavy Duty Spherical Plain Bearing GE 90 EW-2RS
Hole \varnothing 90

Note: 90

Measures

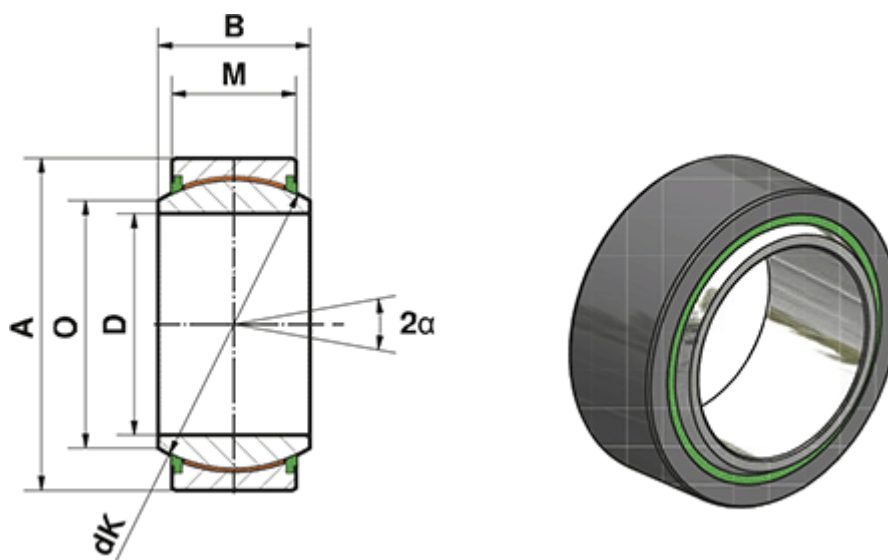

A	= 130	Static load C0 (kN) = 2300
a (degrees)	= 5	Weight (g) = 2700
B	= 60	
D	= 90	
dk	= 115	
Dynamic load C (kN)	= 1380	
M	= 50	
O	= 98.1	